



KHANYISANI



Principles
for
Egg Production



By Dr Guy Stubbs

Narrative by Amie Harms

Artwork by Carissa Gagashi

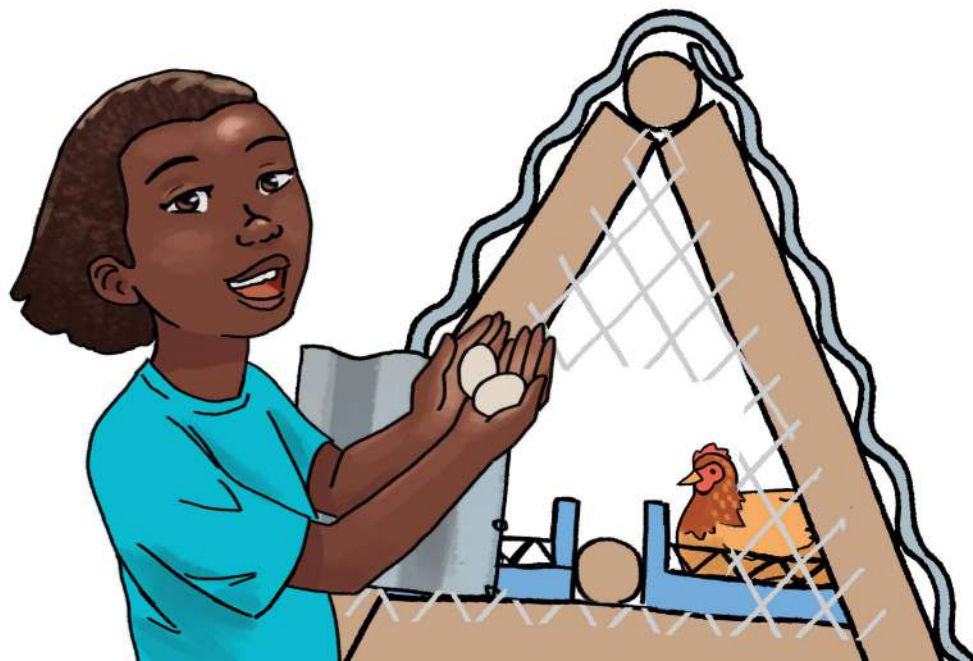

Supplies you will need:

- Poles**
 - 3m long - 2 poles
 - 3.6m long - 1 pole
 - 1.5m long - 6 poles
 - 0.75m long - 2 poles
 - 3m long - thin roosting pole
- Wire and wire cutters**
- Nails and hammer**
- Saw**
- Corrugated iron**
- Chicken mesh**
- Measuring tape**
- 2L plastic bottle**
- Crates**
 - 2 bread crates or 4 cold drink crates
- Nest materials**
 - Straw or wood shavings

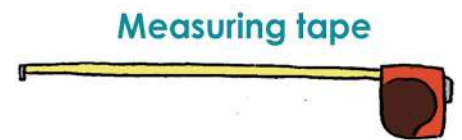

Measuring tape



Wire and wire cutters



Nails and hammer

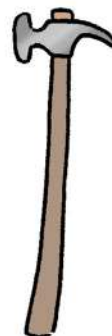

2L bottle

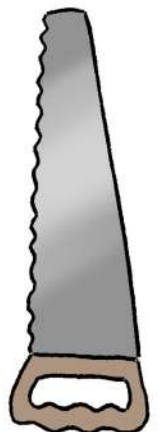

Saw



1x 3.6m

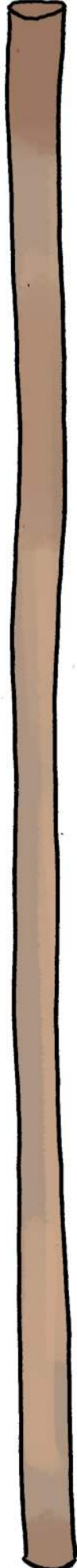

3m thin roosting pole



2x 3m

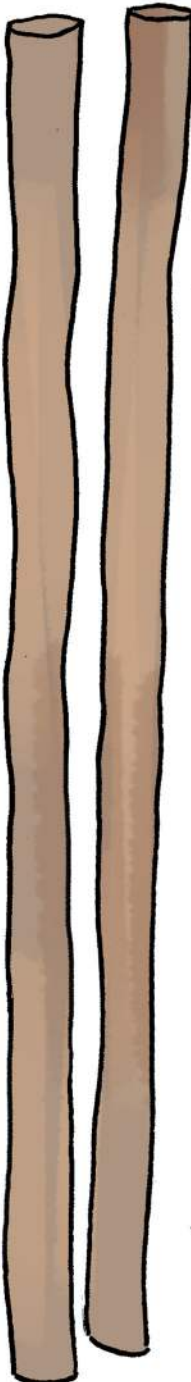

6x 1.5m

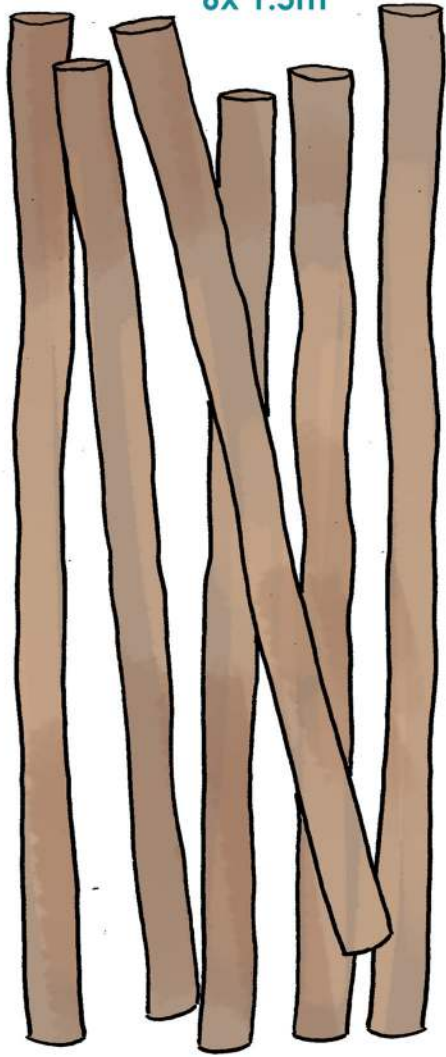

Corrugated iron

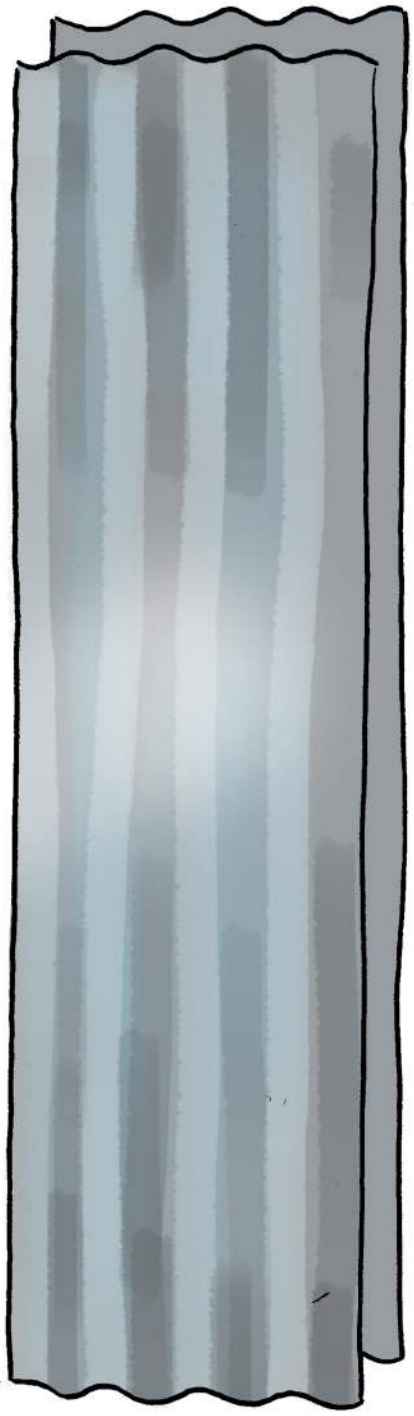

2x 0.75m

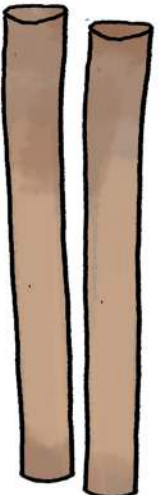

Chicken mesh

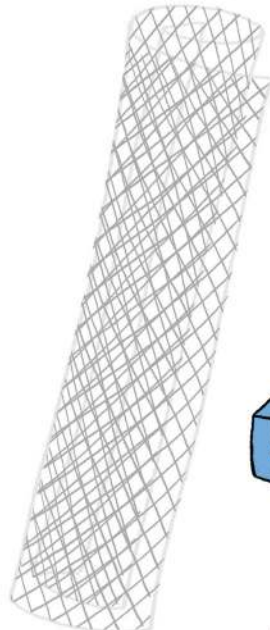

2x Bread crates

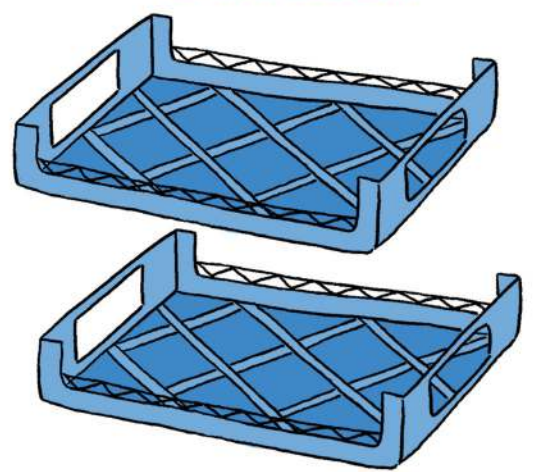

Straw

Principle 1: Get materials from available sources, including recycling and natural resources like trees for poles.

Using local resources and recycling materials can help you make a better profit because it keeps capital (business starting costs) low.

For example, if materials like tree posts are harvested from a forest to build the chicken coop instead of buying poles, it reduces the need for costly materials.

Principle 2: Build an A-frame chicken coop.

Building a strong A-frame is a cheap way to build a chicken coop.

It can also be used as a Chicken Tracktor (this is a chicken coop that can be moved around).

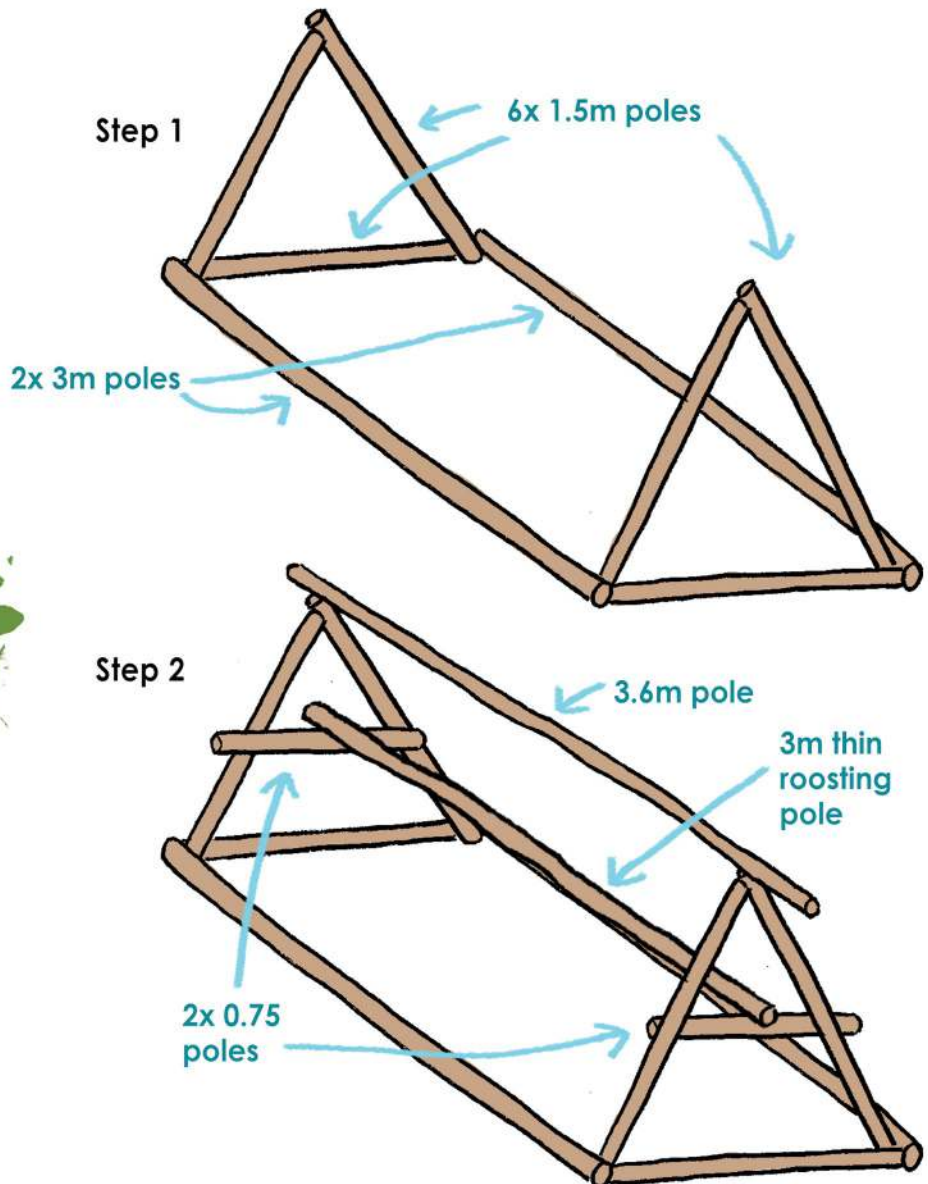

Principle 3: Divide bread crates in half to create egg-laying nests.

Clever use of resources is important in egg production. Dividing crates to make egg-laying nests is a clever way to use available materials and provides spaces for hens to lay eggs. It also helps with hygiene and easy egg collection.

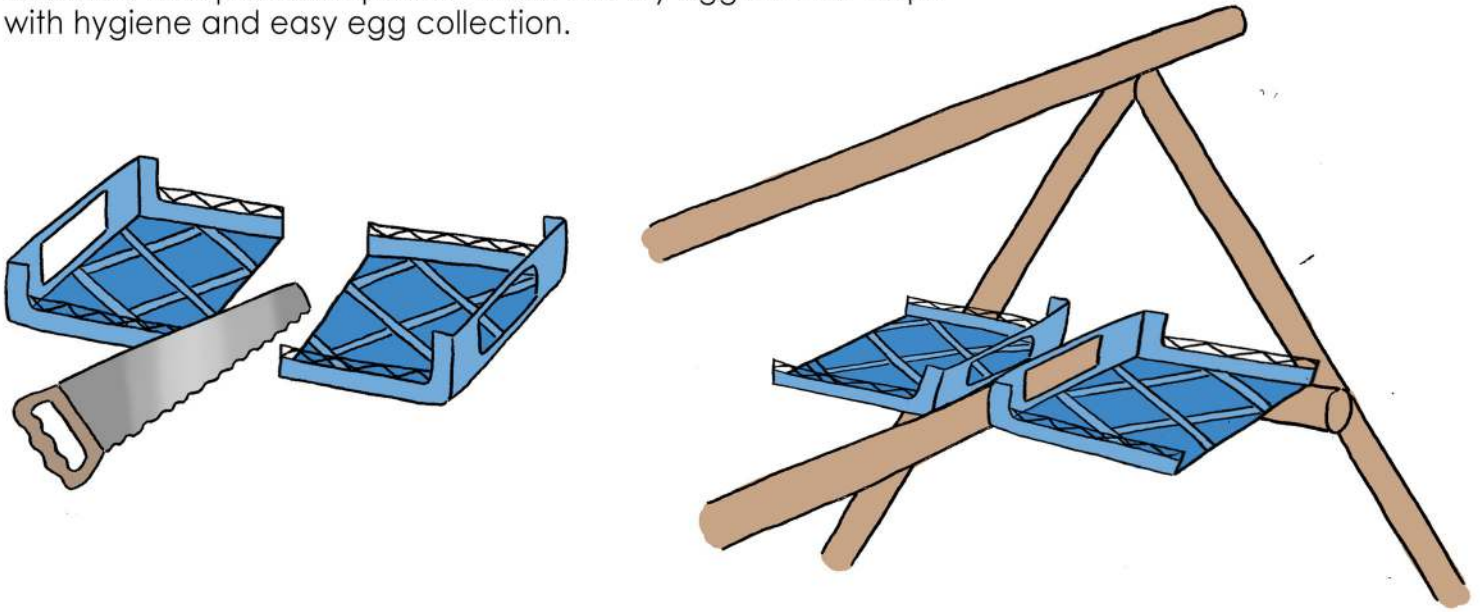

Principle 4: Enhance the nesting boxes by adding straw to the bread crates.

Creating comfortable and secure laying nests by adding straw to the bread crates encourages hens to lay their eggs in designated locations, making egg collection easier and reducing the risk of eggs being laid in undesirable or

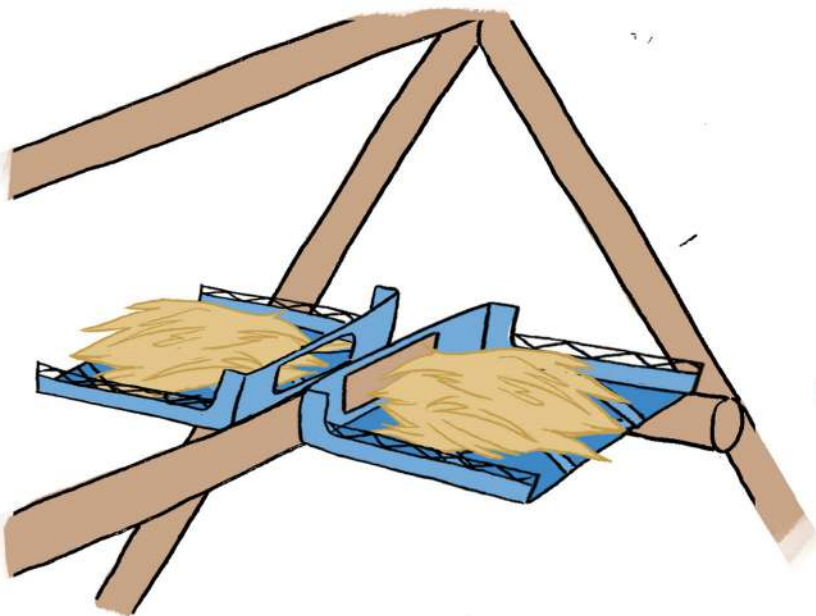

Principle 5: Attach chicken mesh and corrugated iron roofing to the A-frame chicken coop.

Securing chicken mesh to the frame of the coop is essential for creating a safe and predator-resistant environment for the chickens. It helps keep the birds safe from potential threats while allowing for proper ventilation and sunlight. Using corrugated iron for the roof protects the chickens from rain and sun.

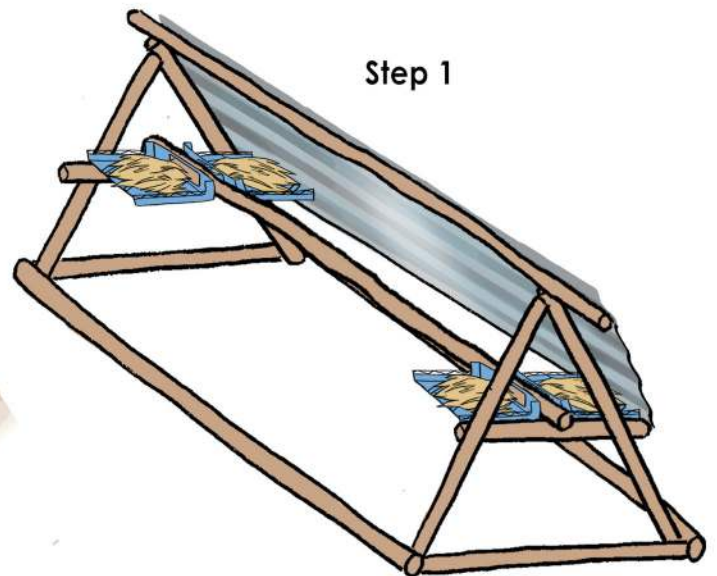

Step 2

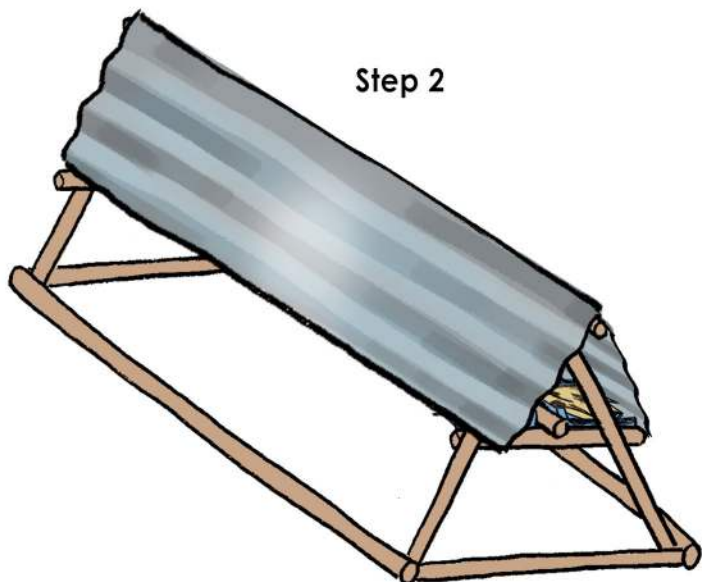

Step 3

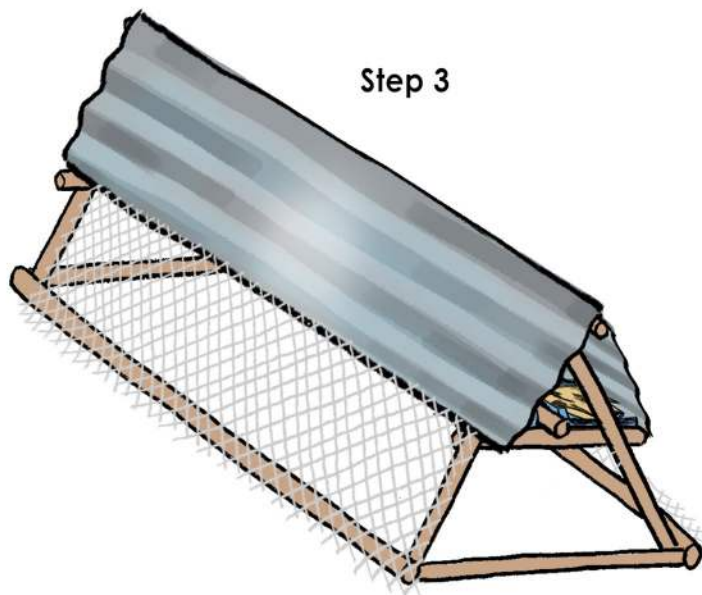

Step 5
Make doors at the top to collect eggs and at the bottom to access feeders.

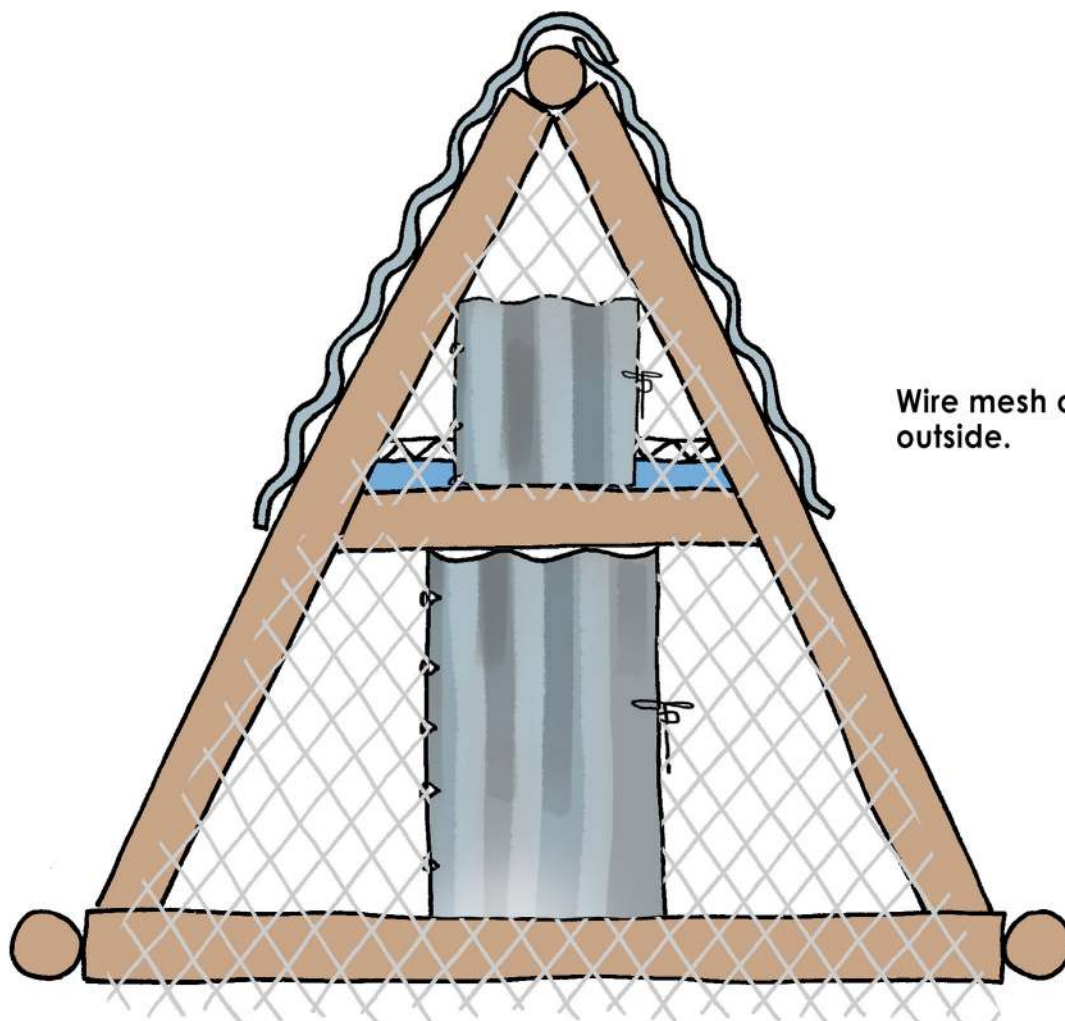

Wire mesh on outside.

Principle 6: Provide roosting poles and laying nests for the chickens' shelter.

Creating comfortable and safe shelter for the chickens is essential. Roosting poles and laying nests provide the chickens with appropriate spaces for resting, roosting, and laying eggs.

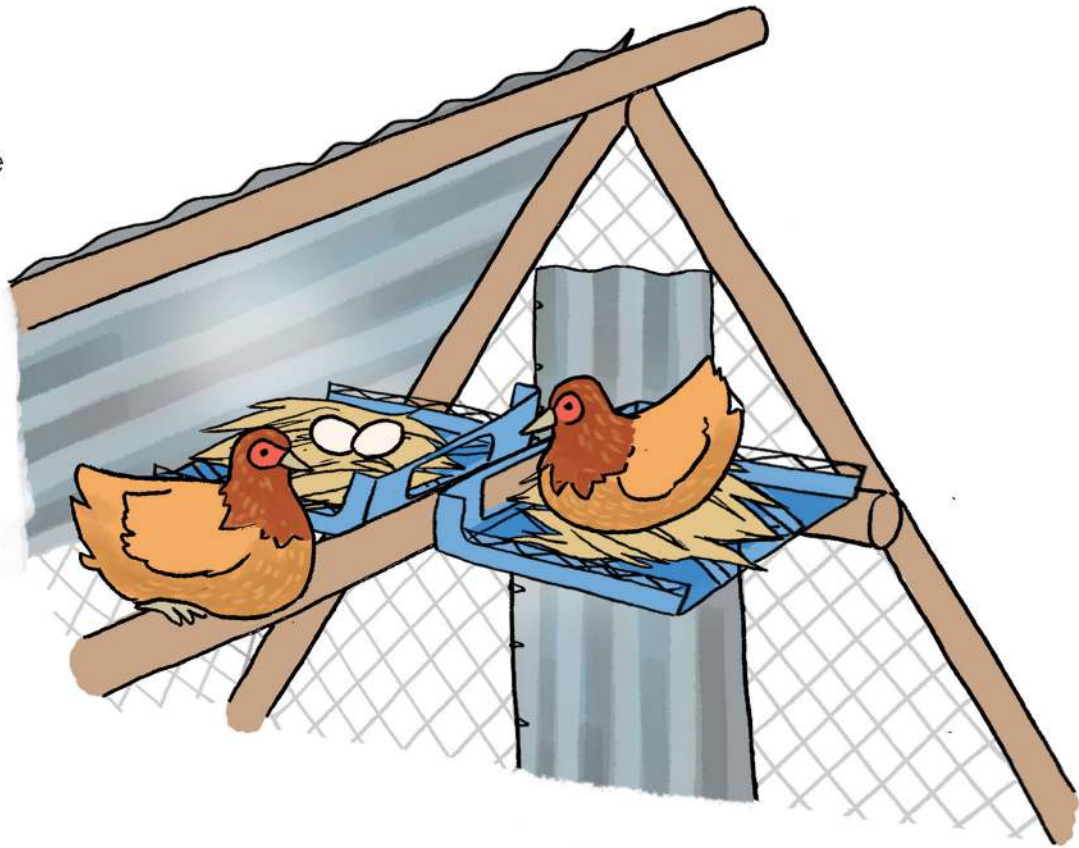

Principle 7: Create cost-effective feeders and drinkers using recycled 2L plastic bottles.

Utilising recycled plastic bottles to create feeders and drinkers is a cost-effective and eco-friendly approach to providing food and water for the chickens. This reduces waste and minimises the need for additional expenses in equipment.

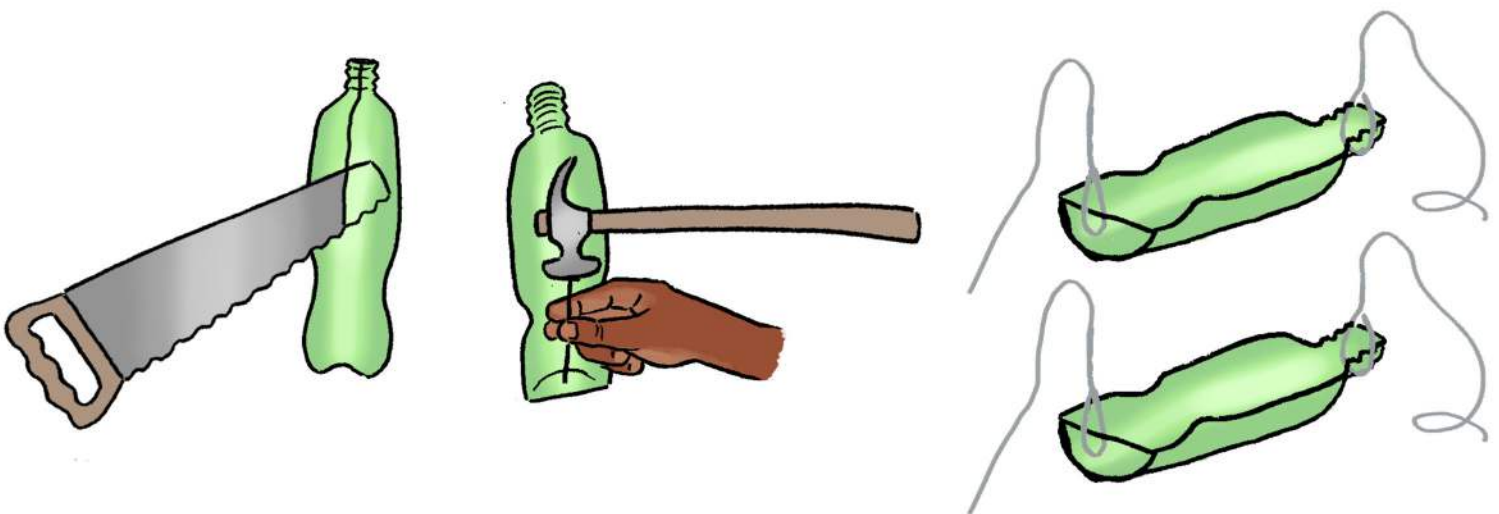

Principle 8: Hang feeding and drinking bowls from the coop.

When you move the chicken coop, the feeders and drinkers go with it. Hang the feeders and drinkers under the nests, close to the doors.

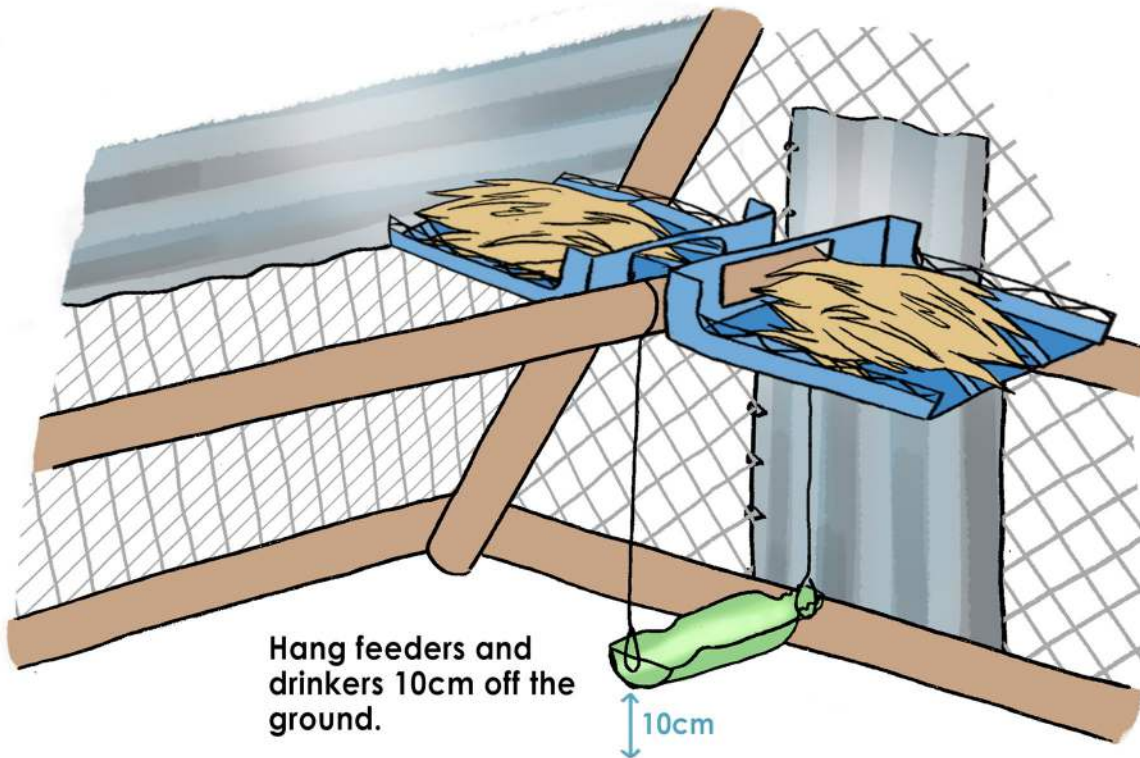

Principle 9: Utilize village chickens rather than commercial layers.

Village chickens are less susceptible to diseases; they sit on their eggs allowing them to hatch out (layers lay all over the place), and village chickens lay in a nest making management easier.

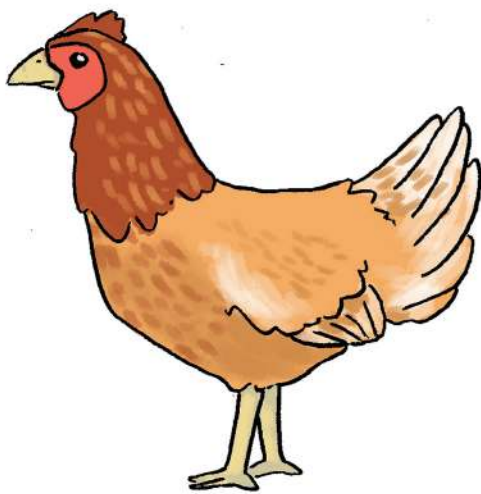

Village chicken

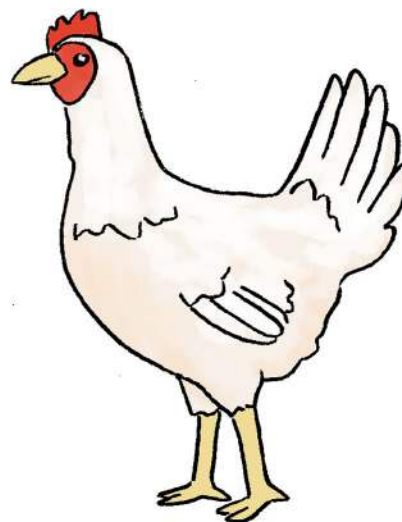

Commercial layer

Principle 10: Select hens aged between 6-12 months for egg production.

Choosing hens within the specified age range for egg production ensures that you have birds in their prime laying period. This maximises egg production efficiency and yield.



2 weeks



15 weeks

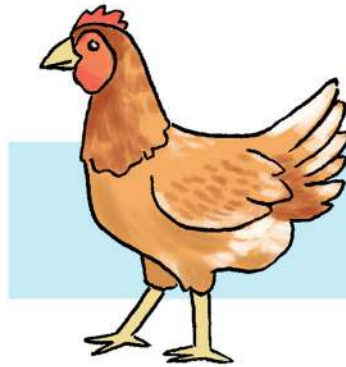

6 months

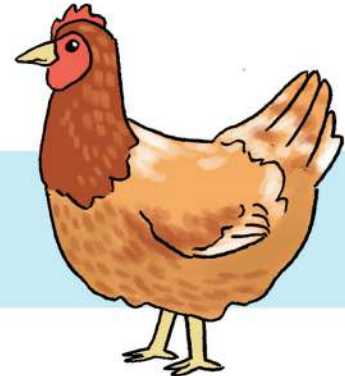

12 months

Principle 11: Allow hens to acclimate to the chicken coop for 2 weeks.

If hens are kept in their coop for two weeks, they will acclimatise and return to sleep in their coops at night, making management possible.

Make sure the chickens always have food and water. Feed them 1 cup of layer pellets per day.

Principle 12: Invest in chicken feed (layer pellets) as the primary expense.

Layer pellets chicken feed is a critical aspect of egg production because it provides the calcium that stimulates the hens to lay and ensures that the hens receive the necessary nutrition to lay eggs consistently.

However, this will be the most expensive part of the operation, so make sure non-laying hens, roosters, and chicks do not eat the layer pellets.



Principle 13: Provide one cup of layer pellets in the evening inside the coop.

Providing a consistent feeding schedule, such as giving layer pellets in the evening, ensures that the hens receive the necessary nutrients for egg production while preventing overeating during the day.



1 cup

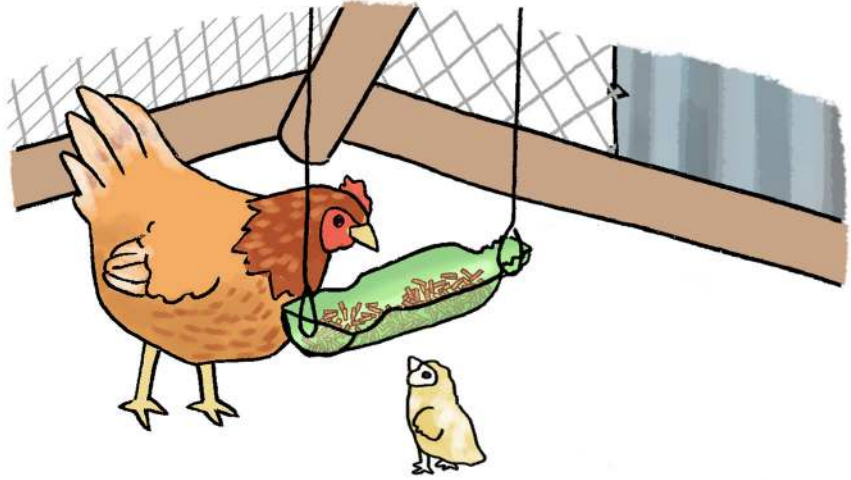

Principle 14: Feed chickens a combination of mixed fowl feed, kitchen scraps, and greens.

A balanced diet is essential for healthy egg production. Feeding chickens a combination of mixed fowl feed, kitchen scraps, and greens not only reduces feed costs but also provides essential nutrients and encourages natural foraging behaviour.



Bread

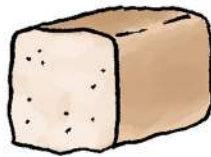

Green vegetables

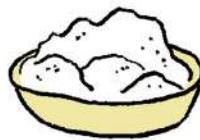

Pap or rice

Principle 15: Allow hens to roam the yard during the day.

Allowing hens to free-range during the day promotes natural behaviour and can enhance the quality of eggs produced. It also reduces the need for additional feed as they can forage for insects and greens.

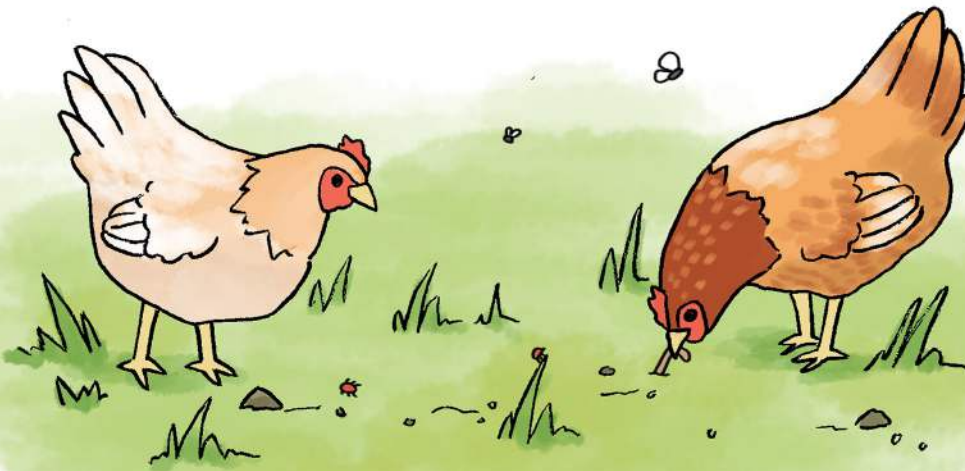

Principle 16: Plant spinach where the coop has been moved to maintain a green food source.

Planting spinach in the areas where the chicken coop is relocated ensures a readily available source of fresh greens, enriching the chickens' diet and potentially enhancing the nutritional content of the meat. Additionally, the chickens will provide good quality manure for growing the spinach.

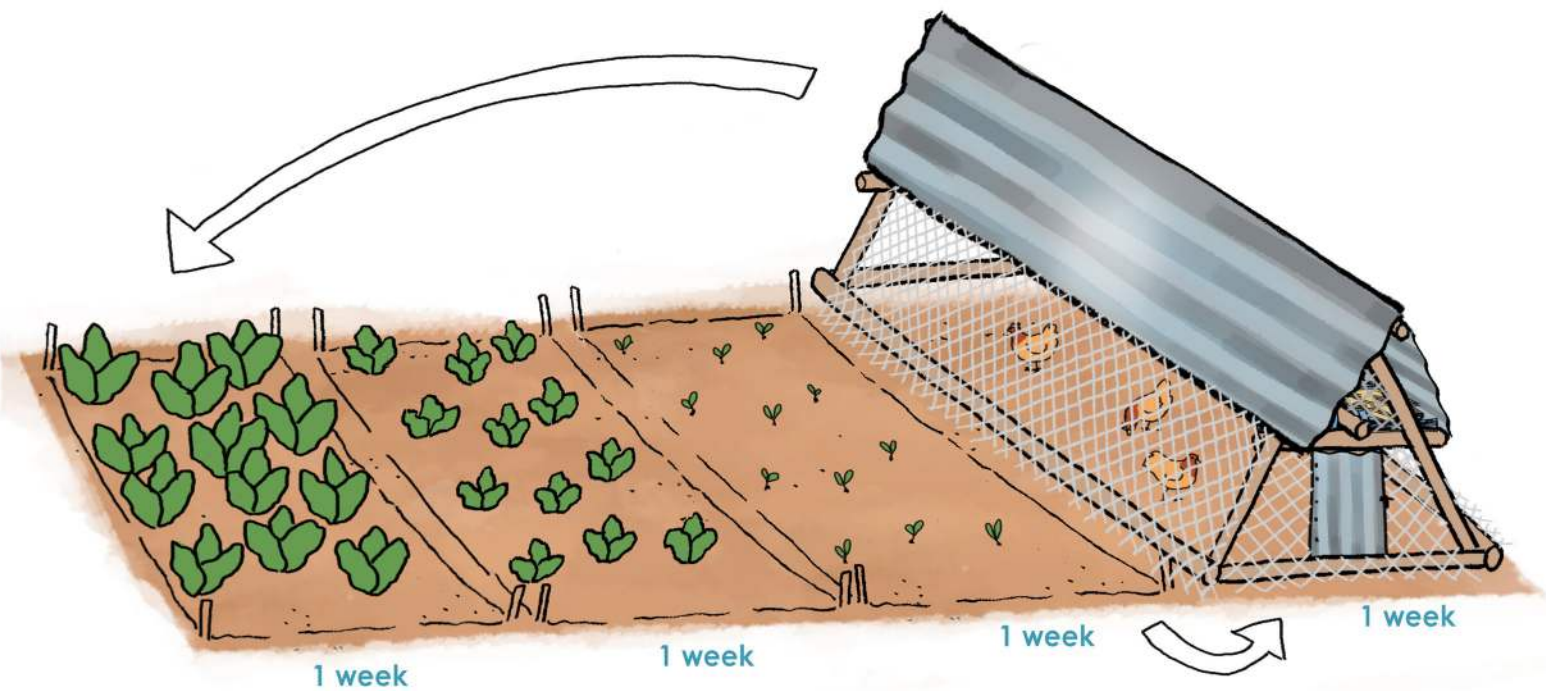



Summary of the Principles of Egg Production (Checklist)

- 1. Acquire materials from available sources, including recycling and natural resources like trees for poles.
- 2. Construct an A-frame chicken coop.
- 3. Divide bread crates in half to create egg-laying nests.
- 4. Enhance the nesting boxes by adding straw to the bread crates.
- 5. Attach chicken mesh and corrugated iron roofing to the A-frame chicken coop.
- 6. Provide roosting poles and laying nests for the chickens' shelter.
- 7. Create cost-effective feeders and drinkers using recycled 2L plastic bottles.
- 8. Hang feeding and drinking bowls from the coop.
- 9. Utilize village chickens rather than commercial layers.
- 10. Select hens aged between 6-12 months for egg production.
- 11. Allow hens to acclimate to the chicken coop for 2 weeks.
- 12. Invest in chicken feed (layer pellets) as the primary expense.
- 13. Provide one cup of layer pellets in the evening inside the coop.
- 14. Feed chickens a combination of mixed fowl feed, kitchen scraps, and greens.
- 15. Allow hens to roam the yard during the day.
- 16. Plant spinach where the coop has been moved to maintain a green food source.





Business Plan for Selling Eggs

10 laying hens (that are between 6 and 12 months old) in the hok.

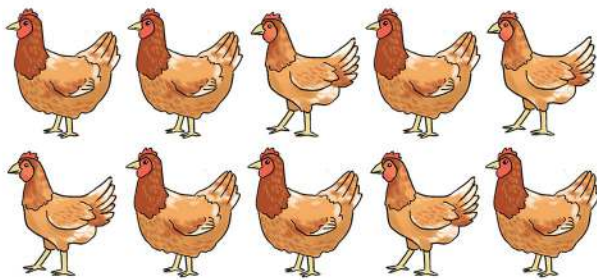

10 chickens

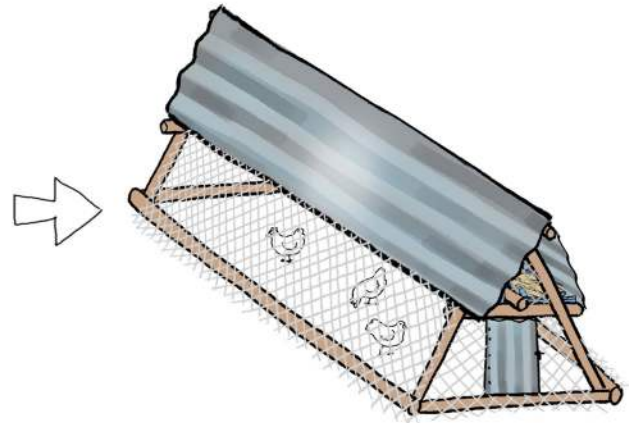

40kg bag of Layer Pellets	R400.00
1 cup per day	4 months

By feedings hens 1 cup of layer pellets per day, the 40kg bag will last 4 months.

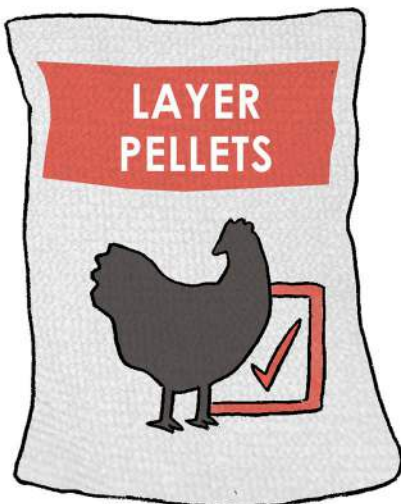

1 cup per day

4 MONTHS

10 laying hens = 200 eggs per month
Sell eggs for R2 each = R400 per month

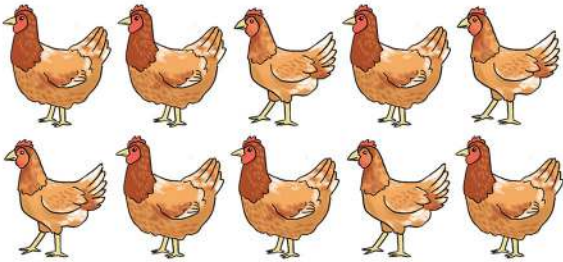

10 chickens



200 eggs per month



200 eggs = **R400**

First month of egg sales will pay for layer pellets. →

40kg bag of Layer Pellets lasts 4 months	-R400.00
200 eggs per month	R400.00
200 eggs per month	R400.00
200 eggs per month	R400.00
200 eggs per month	R400.00

The other 3 months of egg sales = **R1200 profit**



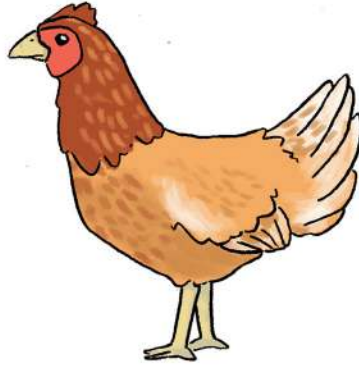

Genesis 1:28

God blessed them and said to them, “Be fruitful and increase in number; fill the earth and subdue it. Rule over the fish in the sea and the birds in the sky and over every living creature that moves on the ground.”



www.childvision.co.za

www.africanhoneybee.co.za